

# ***Section OH-1***

---

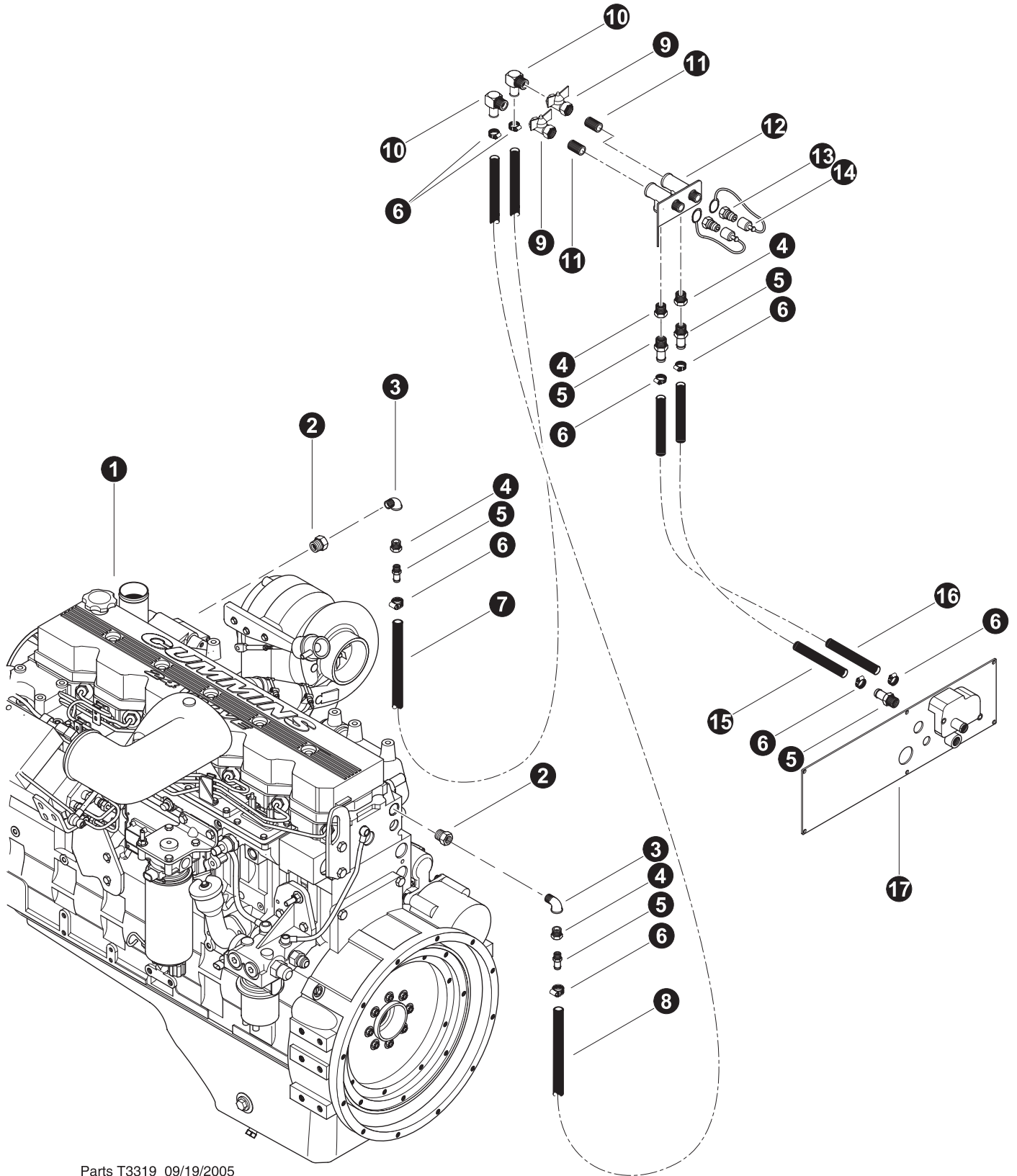



## ***Optional Heaters- Wet Kit Installation***



Parts T3319 09/19/2005  
12.5

## Wet Kit Installation

### (QSC 8.3L Cummins)

REF	PART #	QTY		DESCRIPTION	
1	REF	1		CUMMINS QSC ENGINE ASSEMBLY .....	EE-1
2	15513-OC	2		BUSHING, REDUCER - 5406-12-8	
3	15660-OC	2		ELBOW, BLACK 90 STREET - .5"	
4	15630-OC	4		BUSHING, REDUCER - 5406-8-6	
5	51502-OC	5		NIPPLE, KING - .38NPT X .63 HOSE	
6	10759-OC	8		CLAMP, hose - worm style - 7/8"	
7	16717-OC	60"		HOSE, heater - 5/8" ( <i>shut off valve to engine</i> )	
8	16717-OC	84"		HOSE, heater - 5/8" ( <i>shut off valve to engine</i> )	
9	51714-OC	2		VALVE, BALL - WATER SHUT OFF HEATER 1/2"	
10	52166-OH	2		ELBOW, 90 BRASS - NIPPLE #8 npt x 5/8	
11	16126-OH	2		NIPPLE, CLOSE .5"	
12	51941-OH	1		BRACKET, WET KIT QUICK COUPLERS	
13	17307M-OH	2		QUICK DISCONNECT - male	
-	17307F-OH	2		QUICK DISCONNECT - female (Female connector for supply vehicle)	
14	17323M-OH	2		COVER, Quick Disconnect	
15	16717-OC	61"		HOSE, heater - 5/8" ( <i>wet kit bracket to cab</i> )	
16	16717-OC	62"		HOSE, heater - 5/8" ( <i>wet kit bracket to cab</i> )	
17	REF.	1		BULKHEAD PLATE ASSEMBLY .....	OC-4



Bulk material - order length required in feet or meters.



See referenced page for component or assembly breakdown.





# ***Section OH-2***

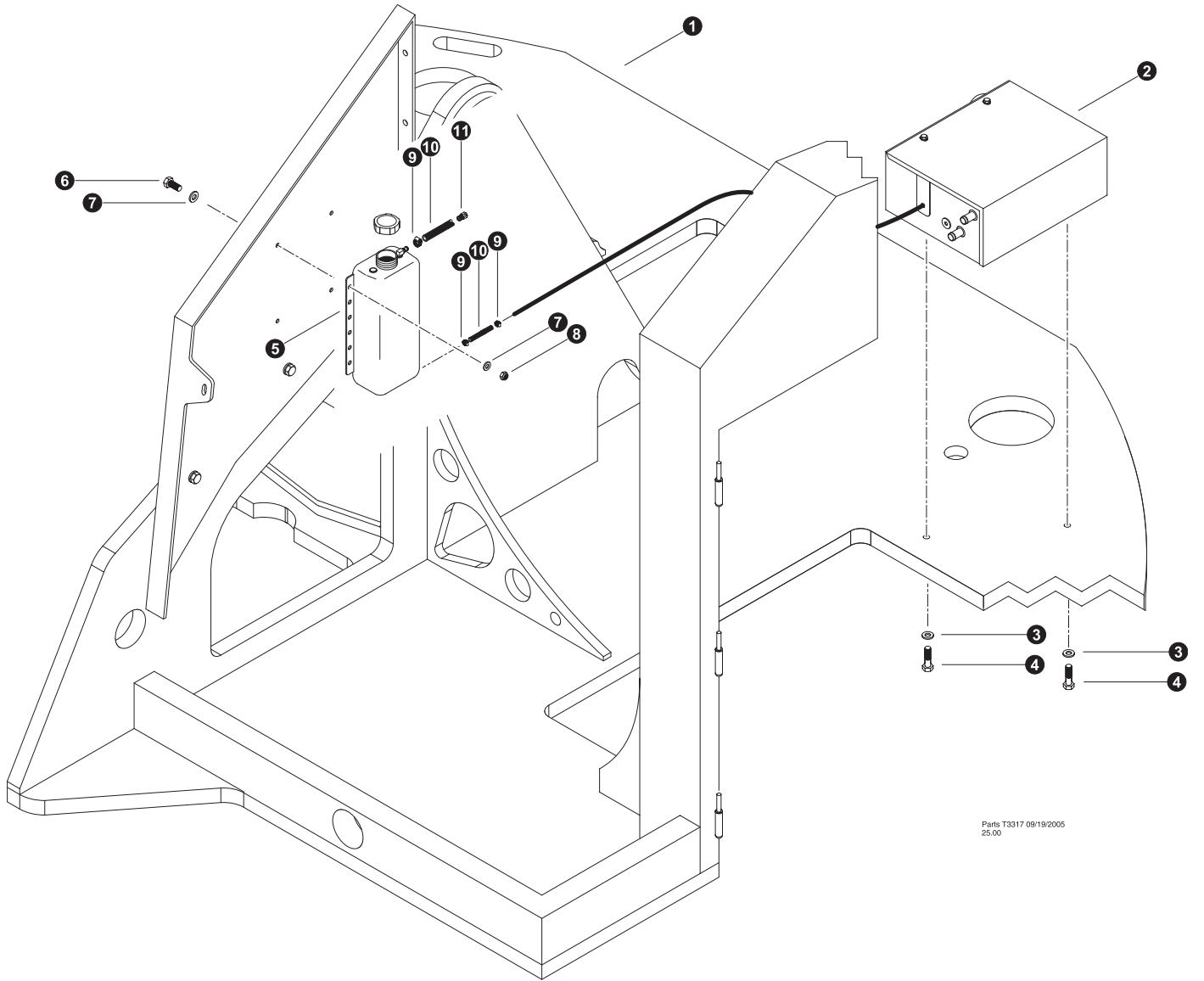

---

## ***Optional Heaters- Espar Heater Installation***



## Espar Heater (Heater Installation)





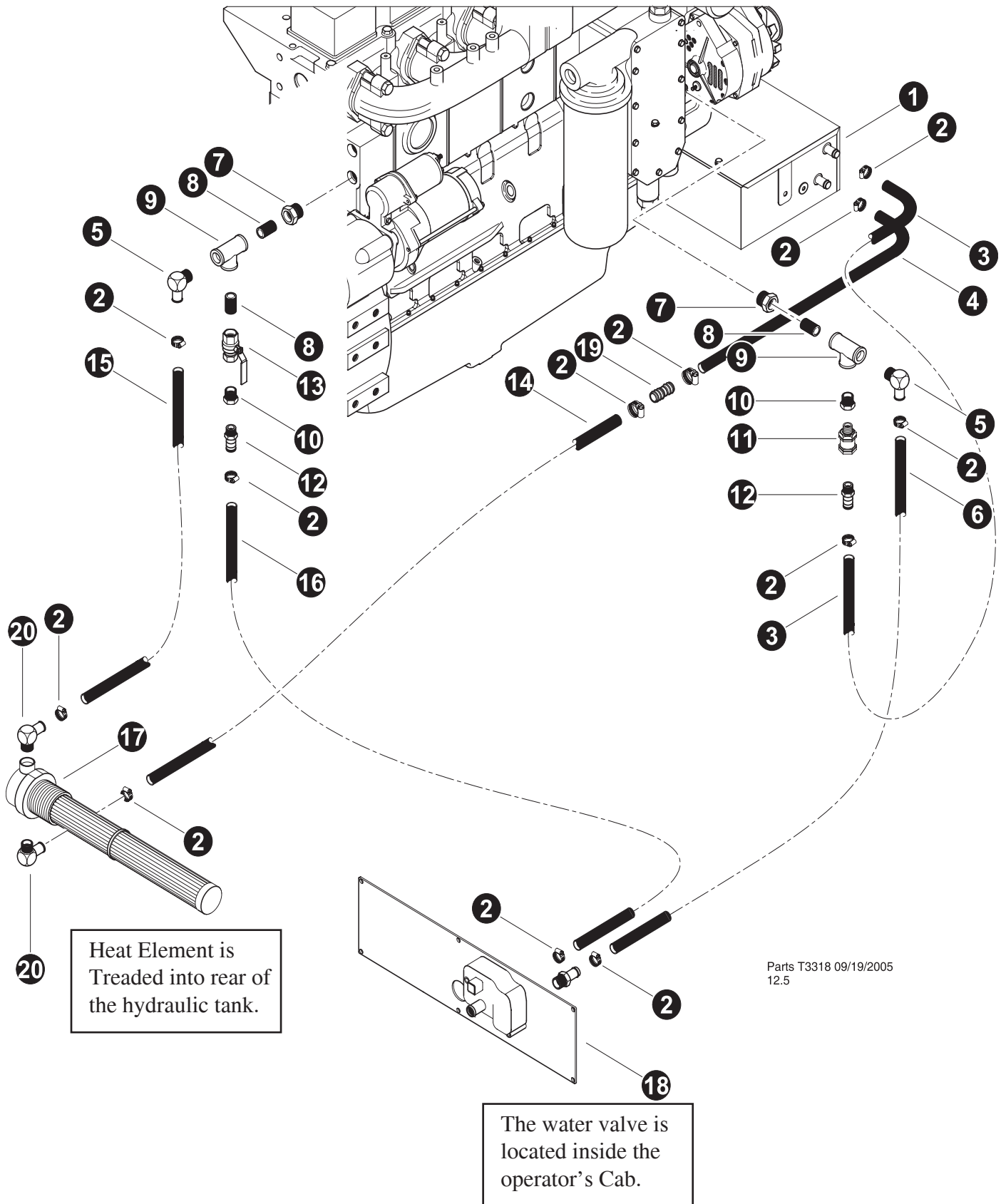

REF	PART #	QTY	DESCRIPTION
1	REF	1	 UPPER TURNTABLE ASSEMBLY ..... UP-1
2	REF	1	 ESPAR PRE-HEATER SYSTEM ..... OH-2
3	15528-OH	2	WASHER, SAE FLAT - .375"
4	15529-OH	2	BOLT - .375" X 2"
5	16925-OH	1	BOTTLE, fuel - (cap included)
6	15589-OH	4	BOLT - .3125" X 1"
7	10801-OH	8	WASHER, FLAT - .3125"
8	10788-OH	4	NUT, NYLOCK - .3125"
9	10759-OH	3	CLAMP, HOSE - WORM STYLE - .875"
10	16238-OH	1	HOSE, FUEL LINE (BULK) - .3125"
11	22906-OH	1	BEATHER, fuel vent



-  Kit or Assembly - includes all items indented underneath.
-  See referenced page for component or assembly breakdown.





## Espar Heater (Heater Installation) Cummins QSC 8.3L

REF	PART #	QTY		DESCRIPTION	
1	REF	1		ESPAR PRE-HEATER SYSTEM .....	OH-2
2	16256-OH	12		CLAMP, HOSE - WORM STYLE - 1"	
3	-OH	1		HOSE, 90 degree (28470)	
4	-OH	1		HOSE, 90 degree (18075)	
5	52166-OH	1		ELBOW, 90 BRASS - NIPPLE #8 npt x 5/8	
6	16717-OH	ft		HOSE, HEATER - (BULK ROLL) .625" X 250'	
7	15513-OH	3		BUSHING, REDUCER - 5406-12-8	
8	16126-OH	3		NIPPLE, CLOSE .5"	
9	16125-OH	2		TEE, BLACK - .5"	
10	15630-OH	2		BUSHING, REDUCER - 5406-8-6	
11	15652-OH	1		VALVE, CHECK - HYDRAULIC/FUEL TANK	
12	51502-OH	2		NIPPLE, KING - .38NPT X .63 HOSE	
13	51714-OH	1		VALVE, BALL - WATER SHUT OFF HEATER 1/2"	
14	16717-OH	ft		HOSE, HEATER - (BULK ROLL) .625" X 250'	
15	16717-OH	ft		HOSE, HEATER - (BULK ROLL) .625" X 250'	
16	16717-OH	ft		HOSE, HEATER - (BULK ROLL) .625" X 250'	
17	51437-OH	1		HEATER, element - Artic Fox	
18	REF	1		WATER VALVE ASSEMBLY .....	OC-3
19	52167-OH	1		CONNECTOR, STR HOSE BARB - 5/8" x 5/8"	
20	51974-OH	1		ELBOW, 90 - 4501-10-12	

-  Bulk material - order length required in feet or meters.
-  Kit or Assembly - includes all items indented underneath.
-  See referenced page for component or assembly breakdown.



# ***Section OH-3***

---

## ***Optional Heaters- Espar Parts Breakdown***

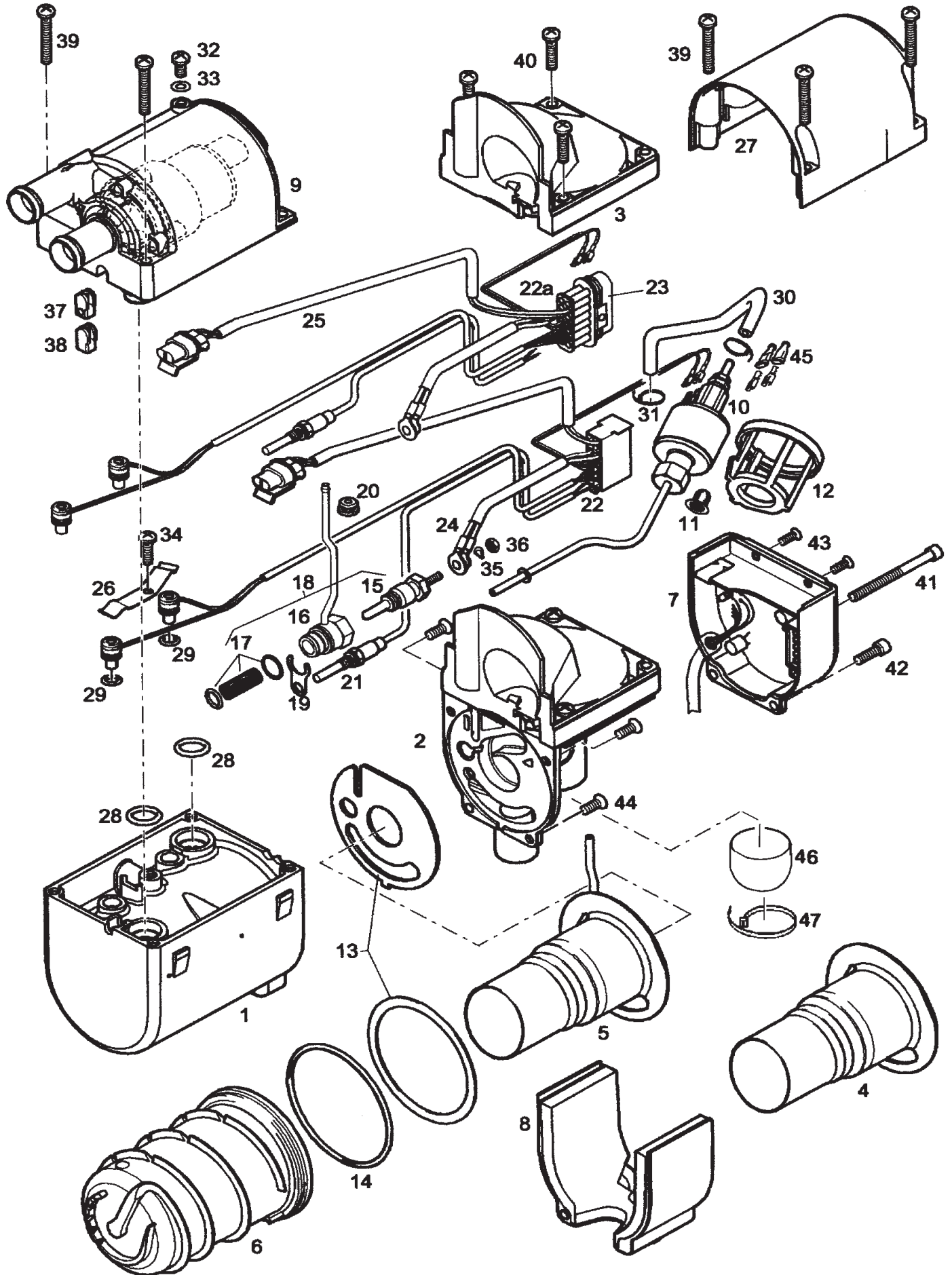

## Espar hydronic - Pre Heater (heater breakdown)

REF	PART #	QTY	DESCRIPTION
-	51578-OH	1	<input type="checkbox"/> KIT, PREHEATER - ESPAR (24V)
1		1	OUTER CASING (251922010101)
2		1	CUMBUSTION AIR BLOWER with COVER (252146991500) .
3		1	COVER (252137010002)
4		1	BURNER
5		1	BURNER (252146100000)
6		1	HEAT EXCHANGER (251922060001)
7		1	CONTROL UNIT (225202001003)
8		1	COVER
9		1	WATER PUMP (252118250000)
10		1	FUEL METERING PUMP (251942450000)
11		1	STRAINER
12		1	PUMP HOLDER (251864990021)
13		1	SEAL & GASKET (251864990021)
14		1	O-RING (32075104)
15		1	GLOW PIN (252107011000)
16		1	GLOW PIN CONNECTION
17		1	LINING AND 2 O-RINGS
18		1	PLUG CONNECTION COMPLETE (252147011300)
19		1	HOLDER (201752010004)
20		1	SLEEVE (201752010002)
21		1	FLAME SENSOR (251920350000)
22		1	OVERHEAT & TEMP SENSORS \ CABLE & CONNECTORS (252147012000)
23		1	CONTROL UNIT PLUG - COMPLETE (221000301010)
24		1	CABLE SECTION, GLOW PLUG (251920011800)
25		1	CABLE, WATER PUMP (201753011800)
26		1	SPRING LEAF (251922010005)
27		1	COVER FUEL METERING PUMP (251917010003)
28		1	ORING (32075119)
29		1	ORING, SENSOR (32075111)
30		1	FUEL HOSE (251917010011)
31		1	HOSE CLIP (20931071)
32		1	BLEED SCREW (251917250012)
33		1	BLEED SCREW WASHER
34		1	TAPITE SCREW (10910104)
35		1	SPRING WASHER (17122112)
36		1	NUT (11010024)
37		1	SLEEVE (251917010005)
38		1	GROMMET
39		1	BOLT M5X35 (10910027)
40		1	BOLT M5X25 (10910102)
41		1	BOLT (10010300)
42		1	BOLT M5X16 (10910101)
43		1	SCREW M4X10 (10910100)
44		1	SCREW (10210400)
45		1	BOOT (32031120)
46		1	DUST COVER (CA000073)

Kit or Assembly - includes all items indented underneath.



## Espar hydronic - Pre Heater (heater breakdown)

REF	PART #	QTY	DESCRIPTION
-	51578-OH	1	<input type="checkbox"/> KIT, PREHEATER - ESPAR (24V
1		1	T-PIECE 20MM (201673801100)
2		1	CONNECTING PIPE (201534880001)
3		1	CLAMP 20MM-32MM (102065020032)
4		1	HOSE (251917800001)
5		1	1.5M PLASTIC FUEL LINE (09031118)
6		1	MOUNT (201185000001)
7		1	HEATER BRACKET (251864800001)
8		1	HOSE CLAMP 9 MM (102063009098)
9		1	HOSE, FUEL (36075300)
10		1	BRACKET (CA010085)
11		1	FUEL LINE 2MM (09031117)
12		1	CLAMP, PIPE 10MM (15200147)
13		1	FUEL PIPE REDUCER (CA012092)
14		1	FUEL PICK UP (CA012056)
15		1	MAIN HEATER HARNESS (CA160502-001)
16		1	EXHAUST CLAMP 27-30MM (15261102)
17		1	INTAKE HOSE CLAMP102064016025)
18		1	C CLAMP 28MM (15210051)
19		1	EXHAUST SLEEVE (251729800600)
20		1	EXHAUST HOSE (36061299)
21		1	INTAKE HOSE (36000099)
22		1	COMPRESSION FITTING
23		1	STRAIT PICKUP TUBE
24		1	BULB 24V (20700006)
25		1	SWITCH 24V (CA100004)
26		1	MUFFLER (251864810100)
27		1	CLAMP (201533880007)
28		1	RELAY 24V (20300092)
29		1	HARNESS ADAPTER, TIMER (CA160008001)
30		1	BEZEL, TIMER (251482700700)
31		1	TIMER, 7 DAY (221000303600) KIT WHARNESS (CA100136)
32		1	BRACKET, TIMER (CA010061)
33		1	FAULT CODE DEVICE (CA105020)
34		1	MAIN FUSE HOLDER (CA107001)
35		1	FUSE (CA107005)
36		1	WIRE, RED (CA161908)
37		1	HARNESS, FAULT CODE (CA105028)
38		1	TERMINAL 3/8" (CA190014)
39		1	FUSE LINK HARNESS (CA165108)
40		1	DOUBLE PICKUP (CA012057001)
41		1	SPACER (251864800002)
42		1	SCREW (CA300103)
43		1	REPLACEMENT HARDWARE KIT (CA100190)
44		1	BRACKET, FRAME MOUNT (CA010028)
45		1	BOX, BASE (CA010101) LID (CA010102)
46		1	PLUG CABLES - COMPLETE (221000301021)
47		1	FUEL PUMP 24V (221000500300)
48		1	BOOT SLEEVE (32031120)
49		1	FUEL PUMP HOLDER (221000500300)
50		1	FILTER, FUEL (224502000100)

